

AN ROINN OIDEACHAIS
(Department of Education).

BRAINNSE AN MHEÁN-OIDEACHAIS
(Secondary Education Branch).

LEAVING CERTIFICATE EXAMINATION, 1934.

PASS.

MECHANICAL DRAWING AND DESIGN.

BOYS AND GIRLS.

TUESDAY, 19th JUNE.—AFTERNOON, 4 TO 6 P.M.

BOYS ONLY.

NOTE.—The use of mathematical instruments, protractors, scales, T- and set squares, and drawing-boards is allowed.

All construction lines must be clearly shown.

The number of the question must be distinctly marked by the side of each answer. Both sides of the paper may be used.

Questions marked (*) have accompanying diagrams.

The number of marks assigned to each question is stated in brackets after the question.

Q. 1. Within a rectangle $4\frac{1}{2}$ inches by $1\frac{1}{2}$ inches draw with pencil, pen or brush, in letters proportionate to the space, the word **TORAÖ**, in Gaelic letters,

Or,

The word **FRUIT** in Roman letters.

[8]

*Q. 2. The diagram represents a hinge. Draw full-size to the dimensions indicated.

[10]

*Q. 3. Draw the given diagram of a window to the scale of 1 inch to 1 foot, using the figured dimensions.

[10]

*Q. 4. The elevation is given of a triangular piece of thin sheet-metal through which a circular hole has been cut. Draw, full-size, a new elevation when its surface is vertical and inclined at an angle of 30° to the vertical plane of projection. The thickness of the metal is to be ignored.

[11]

*Q. 5. The diagram shows the plan and elevation of a ventilator. Draw a new elevation of the ventilator on a vertical plane represented in plan by **X'Y'** Scale 1 inch to 1 foot.

[14]

Q. 6. Draw a design for the top of a hexagonal box to occupy a regular hexagon of $2\frac{1}{4}$ inches side. The design is to include an initial letter or monogram, and should be suitable for reproduction in Metal Repoussé, Inlay or Modelled Leather.

Two tones of one colour may be used, or the design may be finished in black and white.

[22]

GIRLS ONLY.

NOTE.—The use of mathematical instruments, protractors, scales, T^s and set squares, and drawing-boards is allowed.

All construction lines must be clearly shown.

The number of the question must be distinctly marked by the side of each answer. Both sides of the paper may be used.

Questions marked (*) have accompanying diagrams.

The number of marks assigned to each question is stated in brackets after the question.

Q. 1. Within a rectangle $4\frac{1}{2}$ inches by $1\frac{1}{2}$ inches, draw with pencil, pen or brush, in letters proportionate to the space, the word **TORAÒ** in Gaelic letters,

Or,

The word **FRUIT** in Roman letters.

[8]

*Q. 2. A border for embroidery is shown in diagram. Draw two repeats according to the figured dimensions.

[9]

*Q. 3. Copy the diagram to the dimensions shown.

[11]

*Q. 4. Set out what you consider the necessary construction lines for the given Diaper pattern according to the dimensions given.

Complete *one-half* of the diagram.

[11]

*Q. 5. The diagram shows the plan and elevation of a Sugar Dredger. Draw the plan and elevation, and show how you would project the given ornament on to the face **A**.

The true shape of a face with ornament thereon is given.

[14]

Q. 6. Draw a design for a Cushion-cover to occupy a regular hexagon $2\frac{1}{2}$ inches side. The design is to include an initial letter or monogram, and should be suitable for reproduction in Embroidery, Stencilling, or Modelled Leather.

Two colours may be used, or your design may be finished in black and white.

[22]

GIRLS ONLY.

Q2.

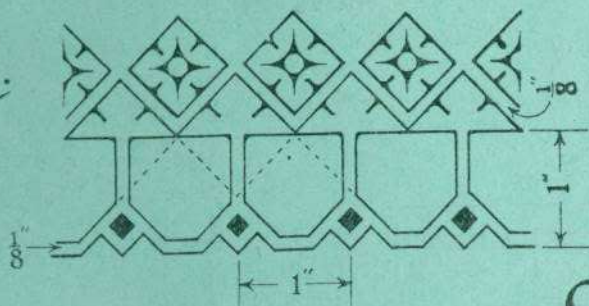

Q3.

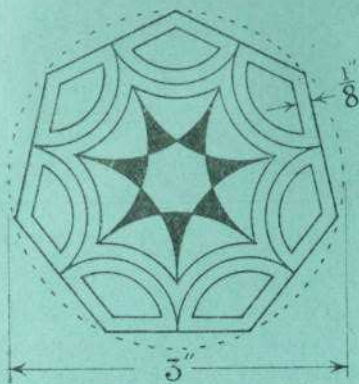

Q4.

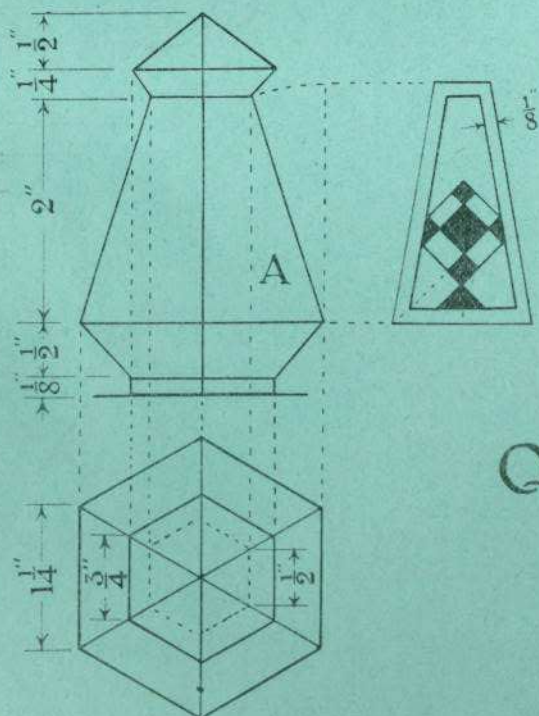
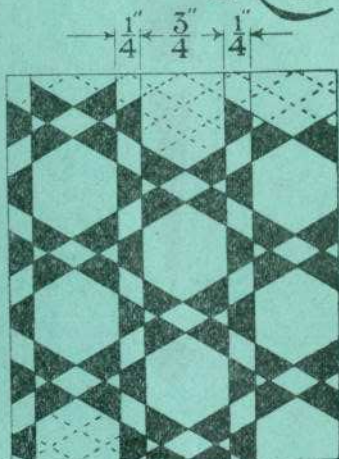

Q5.

BOYS ONLY.

Q 2.

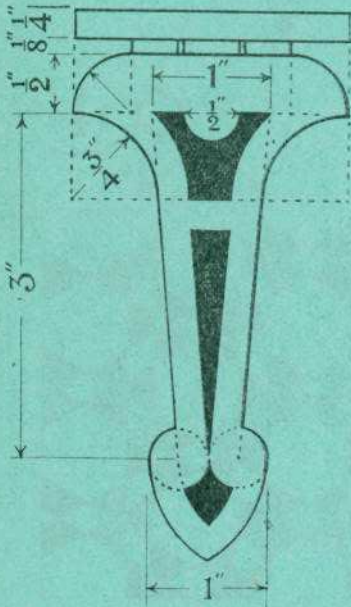

Q 3.

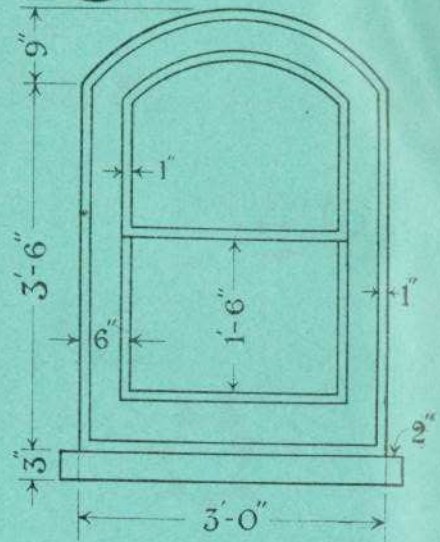

Q 4.

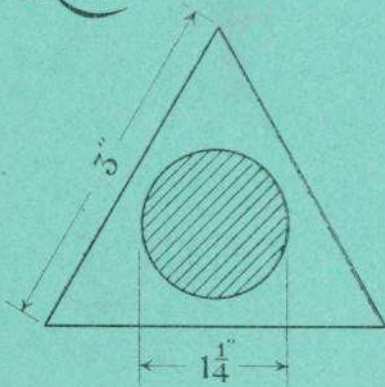

Q 5.

